

TRIM MOULDING



AZEK[®]
Building Products 
Designed to last beautifully.™

AZEK Trim, the #1 brand of trim, offers the unequaled combination of Uniformity, Durability, Workability and Beauty. AZEK Trim products are available in trim, sheets, cornerboards and beadboard, as well as other unique trim products that solve common construction challenges.

The first brand of trim with a building code report (ESR-1074), AZEK Trim has the look and feel of real wood yet requires little maintenance to provide lasting curb appeal.

Using traditional tools and fasteners, AZEK Trim products can be worked similar to wood — even mitered, routed and turned on a lathe. For custom applications, AZEK Trim products can be laminated and heat formed to create curves.





WHY IS AZEK TRIM THE #1 BRAND OF TRIM?

- Over 25 years of cellular pvc manufacturing experience.
- State-of-the-art manufacturing facilities.
- Confidence of a Building Code Report ESR-1074.
- Maintains a “like new” appearance even in the harshest of weather conditions.





AZEK TRIM, THE #1 BRAND OF TRIM, OFFERS THE BEST IN QUALITY

Consumer Focus

Beauty	AZEK
Semi-matte White Finish	●
White Color Throughout Profile	●
Maintains Its Original Color Without Protection	●
Readily Accepts Paints	●

Durability	AZEK
Never Requires Paint for Protection	●
Will Not Rot, Cup, Split, Twist or Warp	●
Impervious to Moisture and Insects	●
Suitable for Ground/Masonry Contact	●
25-Year Warranty	●

Contractor Focus

Workability	AZEK
Use Standard Woodworking Tools	●
Can be Milled, Shaped and Moulded	●
Can be Heat Formed for Curved Applications	●
Fasten Close to Edge Without Splits	●
Can Rout or Cut without "Chip Outs"	●

Uniformity	AZEK
Consistent Density	●
Square Edges	●
No Voids	●
No Waste, Every Inch Usable	●

25-YEAR LIMITED WARRANTY

PERFECT FOR GROUND CONTACT APPLICATIONS
IMPERVIOUS TO MOISTURE AND INSECTS
DOES NOT REQUIRE PAINT FOR PROTECTION
CAN BE HEAT FORMED FOR UNIQUE SHAPES AND DESIGNS
BUILDING CODE LISTING ESR-1074



With the AZEK Edge

- Precise, sealed edges on all 4 sides (S4S).
- Stays cleaner in the lumberyard and job site.
- Tight board tolerances.
- Easier to clean if it does get dirty.

With unparalleled quality, AZEK Trim products are backed by a proven track record of performance that tops all competitors. For a trim product that will offer years of lasting good looks, choose AZEK Trim.



See for yourself!

PRODUCT OFFERING

AZEK Trim



AZEK Cornerboard



AZEK Beadboard



AZEK Finish Grade Trim*



AZEK Universal Skirt Board*



AZEK Integrated Drip Edge



AZEK Rabbeted Cornerboard & Trim



AZEK Sheet



AZEK to Mill (ATM)



AZEK Adhesive



* Patent Pending





Traditional

- Natural, semi-matte white on both sides
- Look, feel and sound of clear lumber
- Available in board, cornerboard, beadboard, AZEK to Mill, sheets, and Finish Grade Trim

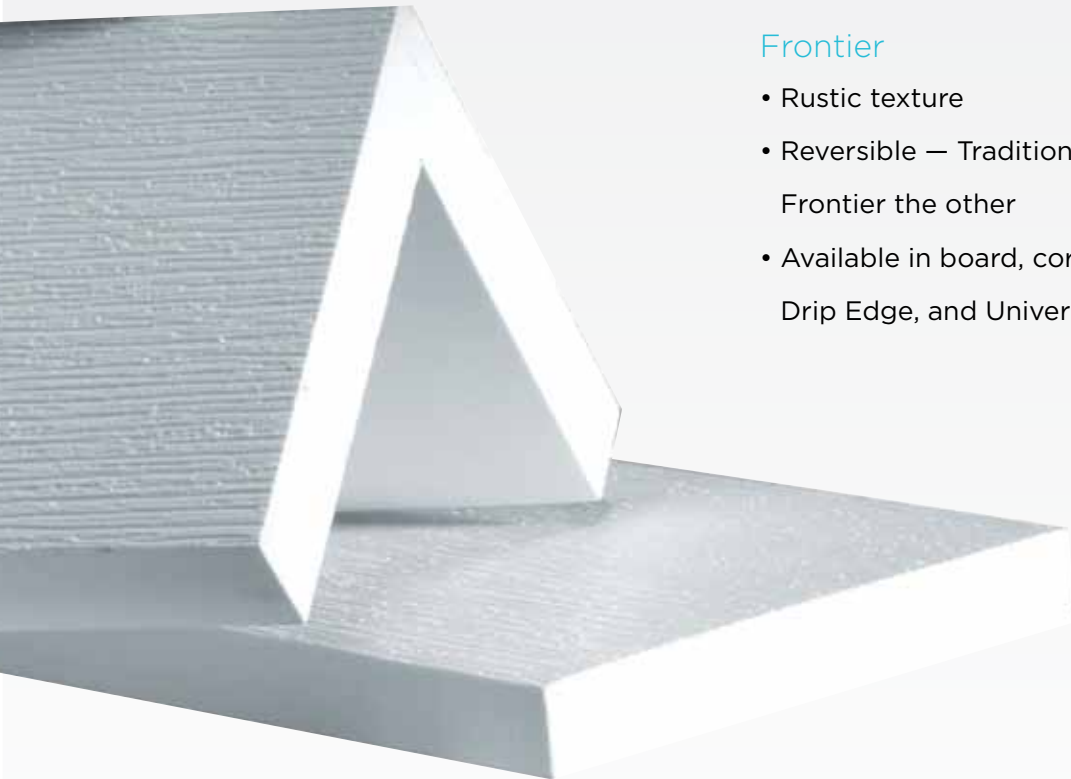

Frontier

- Rustic texture
- Reversible — Traditional one side, Frontier the other
- Available in board, cornerboard, Integrated Drip Edge, and Universal skirt board





MOST AZEK TRIM PRODUCTS
AVAILABLE IN EITHER TRADITIONAL
OR FRONTIER FINISH.



AZEK Trim (Traditional and Frontier)

Trim that is easy to work with and offers long lasting durability. It's the perfect replacement for wood in all non-stress and non-load bearing applications. Easily milled and routed for custom looks. Doesn't require paint for protection, but can be painted for aesthetics.

5/8" x Thickness

Actual	Lengths
5/8" x 3 1/2"	12' and 18'
5/8" x 5 1/2"	12' and 18'
5/8" x 7 1/4"	12' and 18'
5/8" x 9 1/4"	12' and 18'
5/8" x 11 1/4"	12' and 18'
5/8" x 15 1/4"	12' and 18'

4/4" x Thickness

Nominal	Actual	Lengths
1 x 2	3/4" x 1 1/2"	18'
1 x 4	3/4" x 3 1/2"	12' and 18'
1 x 5	3/4" x 4 1/2"	12' and 18'
1 x 6	3/4" x 5 1/2"	12' and 18'
1 x 8	3/4" x 7 1/4"	12' and 18'
1 x 10	3/4" x 9 1/4"	12' and 18'
1 x 12	3/4" x 11 1/4"	12' and 18'
1 x 16	3/4" x 15 1/4"	12' and 18'

5/4" x Thickness

Nominal	Actual	Lengths
5/4 x 4	1" x 3 1/2"	12', 18', and 20'
5/4 x 5	1" x 4 1/2"	12', 18', and 20'
5/4 x 6	1" x 5 1/2"	12', 18', and 20'
5/4 x 8	1" x 7 1/4"	12', 18', and 20'
5/4 x 10	1" x 9 1/4"	12', 18', and 20'
5/4 x 12	1" x 11 1/4"	12', 18', and 20'
5/4 x 16	1" x 15 1/4"	12', 18', and 20'

6/4" x Thickness (Frontier Only)

Nominal	Actual	Lengths
6/4 x 4	1 1/4" x 3 1/2"	20'
6/4 x 6	1 1/4" x 5 1/2"	20'
6/4 x 8	1 1/4" x 7 1/4"	20'
6/4 x 10	1 1/4" x 9 1/4"	20'
6/4 x 12	1 1/4" x 11 1/4"	20'

AZEK Finish Grade Trim* (Traditional)

Two-piece trim system installs quickly and easily, saving time and labor costs while providing a beautiful, smooth, fastener-free trim surface. No more need to fill, paint and sand nail holes. Perfect for door and window surrounds, but could be used in nearly any trim application.

Base plate can be quickly and securely face nailed. Then the cover trim fits neatly over the base trim and includes a nailing flange to eliminate visible fasteners.

Actual (Approximate installed thickness and width) 6/4" x 6" x 18'

* Patent Pending

AZEK Trim and AZEK Mouldings should be installed using the same good building principles used to install wood or composite trim and mouldings and in accordance with the local building codes and established installation guidelines. AZEK Building Products Inc. claims no liability or responsibility for the improper installation of this product.

AZEK Trim and AZEK Moulding may not be suitable for every application and it is the sole responsibility of the installer to be sure that AZEK Trim and Mouldings are fit for the intended use. Since all installations are unique, it is also the installer's responsibility to determine specific requirements in regards to each trim application. AZEK Building Products recommends that all applications be reviewed by a licensed architect, engineer or local building official before installation.

Technical information and AZEK Trim and Moulding Installation Guidelines are available online at www.AZEK.com or from your local AZEK Dealer. If you have any questions or need assistance, please call AZEK Customer Service at 877-ASK-AZEK (877-275-2935) or visit www.AZEK.com.

AZEK Universal Skirt Board*

Providing the perfect transition between the siding and trim, as well as assisting in water management, the two piece Universal Skirt Board includes a reversible trimboard that is routed to accept a proprietary universal siding interface.

Unlike other skirtboards, AZEK Universal Skirt Board will work equally well with a variety of siding products including fiber cement, vinyl, cedar shingles or wood.

The AZEK Universal Skirt Board reduces labor, saves installation time and costs, and replaces the need for starter strips. And it is perfect for use where water tables are not needed or desired. Once interface snaps with trimboard, it cannot be removed.

Trimboard (Nominal Size)

5/4 x 6 x 18'

5/4 x 8 x 18'

1/2" nailing flange length

1/4" drip edge overhang

AZEK Beadboard

Reversible beadboard profile with edge/center bead on one side and v-groove on the other side. This design offers flexibility when planning your project. Perfect for wainscoting and porch ceiling.

1/2" Beadboard has a nailing flange for easier installation.

Actual

5/8" x 3 1/2" x 18'

1/2" x 5 1/2" x 18'

AZEK Cornerboard (Traditional and Frontier)

With a seam that will not open, AZEK Cornerboards offer time savings during installation while providing an upscale look. Available in Traditional and rustic Frontier, in 10' and 20', to complement any housing exterior.

5/4 x Thickness

Nominal	Actual
5/4 x 4 x 4 x 10'	1" x 3 1/2" x 3 1/2"
5/4 x 4 x 4 x 20'	1" x 5 1/2" x 5 1/2"
5/4 x 6 x 6 x 10'	1" x 3 1/2" x 3 1/2"
5/4 x 6 x 6 x 20'	1" x 5 1/2" x 5 1/2"

6/4 x Thickness

Nominal	Actual
6/4 x 4 x 4 x 10'	1 1/4" x 3 1/2" x 3 1/2"
6/4 x 6 x 6 x 10'	1 1/4" x 5 1/2" x 5 1/2"

AZEK Integrated Drip Edge*

Trim product designed to assist with water management efforts around window and door surrounds. The two piece product, which includes a reversible trimboard, is routed to accept a drip edge designed to help channel water away from the window or door surround. For easy installation, the drip edge has an integrated nailing flange to reduce labor and installation costs. Once the drip edge snaps into trimboard, it cannot be removed.

Trimboard (Nominal Size)

5/4 x 4 x 18'

5/4 x 6 x 18'

1/4" nailing flange

1/8" drip edge overhang

AZEK To Mill (ATM)

Perfect for use as a fabrication component due to its thicker profile. Its consistent density and solid color offer a superior product for milling operations.

Actual

1 1/4" x 9 1/4" x 18'

1 1/4" x 48" x 96"

* Patent Pending

AZEK Sheet (Traditional)

Perfect for bay windows, dormers and raised panels. Applications over 16" wide are easy.

Actual

3/8" x 4' x 8'*	3/4" x 4' x 8'
3/8" x 4' x 10'*	3/4" x 4' x 10'
	3/4" x 4' x 12'
1/2" x 4' x 8'*	3/4" x 4' x 18'
1/2" x 4' x 10'*	
	1" x 4' x 8'
5/8" x 4' x 8'	1" x 4' x 10'
5/8" x 4' x 10'	1" x 4' x 12'
5/8" x 4' x 18'	1" x 4' x 20'

*3/8" and 1/2" sheet product is not intended to be ripped into trim pieces. These profiles must be glued to a substrate and mechanically fastened. Contact your AZEK Territory Sales Manager with questions.

AZEK Rabbeted Cornerboard and Trim (Traditional and Frontier)

With rabbeted edges, the one-piece AZEK Rabbeted Cornerboard is designed to ease siding installation and deliver a crisp, clean trim facade. AZEK Rabbeted Trim also eases installation for a clean finish.

Rabbeted Cornerboard 5/4 x Thickness

Nominal	Actual
5/4 x 4 x 4 x 10'	1" x 3 1/2" x 3 1/2"
5/4 x 4 x 4 x 20'	1" x 5 1/2" x 5 1/2"
5/4 x 6 x 6 x 10'	1" x 3 1/2" x 3 1/2"
5/4 x 6 x 6 x 20'	1" x 5 1/2" x 5 1/2"
5/4 x 8 x 8 x 10' [†]	1" x 7 1/4" x 7 1/4"
5/4 x 8 x 8 x 20' [†]	1" x 7 1/4" x 7 1/4"

Rabbeted Trim

Nominal	Actual
5/4 x 4 x 18'	1" x 3 1/2" x 18'
5/4 x 6 x 18'	1" x 5 1/2" x 18'
5/4 x 8 x 18'	1" x 7 1/4" x 18'

AZEK Adhesive

Water-based, non-toxic, easy to clean-up adhesive that's perfect for AZEK to AZEK adhesion. Glued joints will never open.

4 oz.	32 oz.
8 oz.	128 oz.
16 oz.	5 gal.

[†] Traditional only



AZEK Moulding is the perfect match to AZEK Trim. AZEK Mouldings are available in many of the most popular moulding profiles. AZEK products are known for longevity and durability. AZEK Mouldings won't split, crack or rot. They can be installed using traditional tools and fasteners and, for custom applications, AZEK Moulding products can be laminated and heat formed to create curved moulding details.





THE BEST LOOKING,
HIGHEST PERFORMING
WOOD REPLACEMENT LINE
OF MOULDINGS AVAILABLE
IN THE MARKET.

- Breakthrough technology offers the same color, look and feel as AZEK Trim.
- AZEK cellular pvc product offers greater stability and predictability when fastening and minimizes expansion/contraction.
- No painting required, yet easy to paint if a custom color is desired.
- UV protection inside and out.
- Uniform material, same formula as AZEK Trim, to minimize chip outs on cut lengths.
- One warranty covers all products.
- No cupping, swelling, rotting or splitting.
- Use AZEK Adhesive, a proven adhesive for “welding” all AZEK products together, to eliminate joints.
- AZEK Mouldings are installed with similar tried-and-true installation methods as traditional wood mouldings.
- Standard AZEK Installation Guidelines will apply to AZEK Mouldings.
- Pay attention to proper fastening and gluing.

CROWN PROFILES

Crown moulding profiles are typically decorative mouldings designed for use along the intersection of a wall and ceiling. May be combined with other mouldings to create a "built-up" profile.

6" Crown
AZM-45

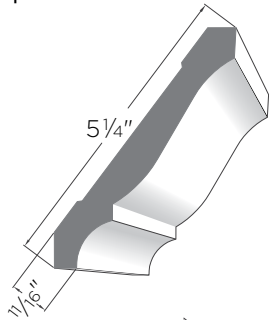

5" Crown
AZM-47

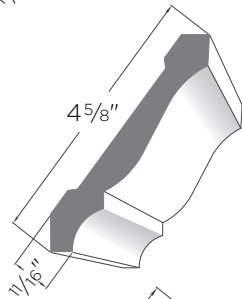

4" Crown
AZM-49

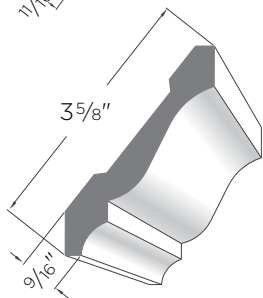

3" Crown
AZM-52

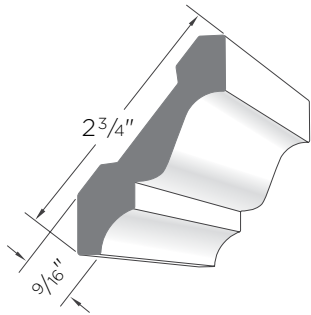

Rams Crown
AZM-6934

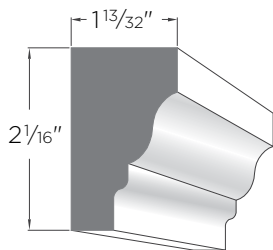

CASING PROFILES

Casing profiles are decorative mouldings typically used flush against a wall, door or window to create surrounds.

Rake Moulding
AZM-287

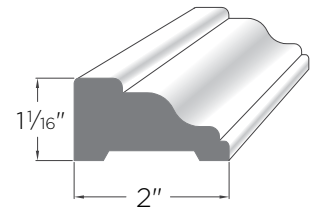

Adams Casing
AZM-97

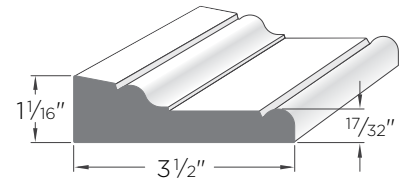

Brick Mould
AZM-180

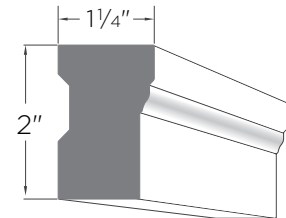

Back Band
AZM-6931

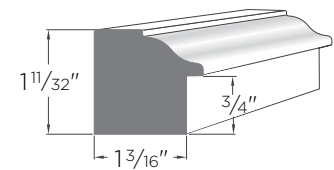

Base Cap
AZM-164

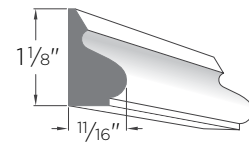

Square Profile
AZM-236

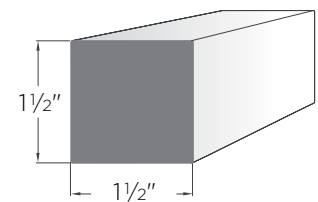

COVE PROFILES

Cove profiles are typically used along the intersection of a wall and ceiling.

Bed Moulding

AZM-75

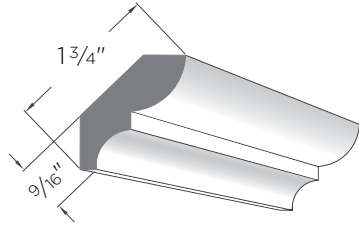

Scotia

AZM-93

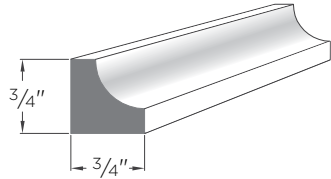

Quarter Round

AZM-105

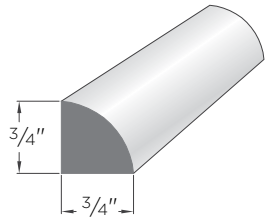

SHINGLE BAND PROFILES

Shingle Band is designed for use as a window or door casing or as a decorative shoe base.

Shingle Mould

AZM-210

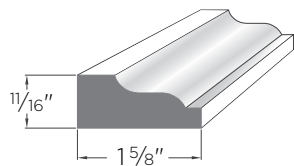

Band Moulding

AZM-217

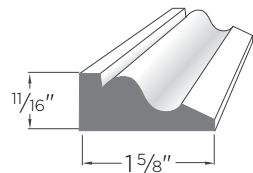

DRIP CAP PROFILES

Drip Cap is typically used as a water table or brick ledge for separation and water shed against two differing material types.

Drip Cap

AZM-197

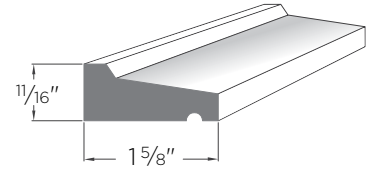

Water Table

AZM-6935

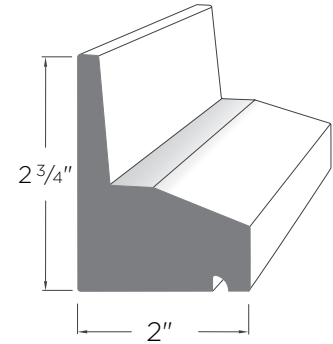

SILL PROFILES

Sill profiles shed water and offer architectural detail.

Historic Sill

AZM-6930

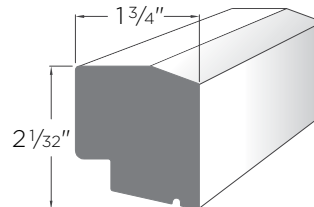

Sub Sill Nose

AZM-6933

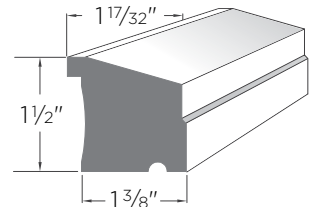

GARAGE DOOR THERMOSTOP

Popular moulding profile designed to assist with sealing new or existing garage door openings to minimize weather and moisture intrusion.

Garage Door Thermostop

AZM-6936

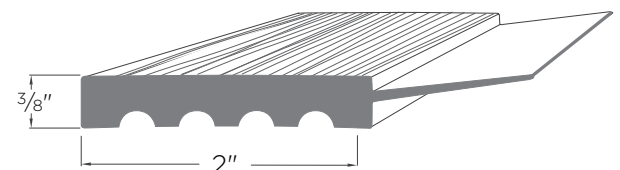

AZEK Building Products, Inc.
801 Corey Street • Scranton, PA 18505
www.AZEK.com • (877) ASK-AZEK
(877) 275-2935

Thank you for considering AZEK Deck, AZEK Porch, and AZEK Rail.
Before purchasing, please visit www.AZEK.com for detailed
installation and product use information.

