

# Turn on your deck with AZEK Rail Lighting



Introducing three great outdoor lighting solutions to bring light and life to your AZEK Rail. Lighted Post Caps and innovative Under Top Rail Lighting are the newest additions to the AZEK Rail product line. Check out these great new rail accessories today!

## UNDER TOP RAIL LIGHTING

- Works with AZEK Premier and Trademark Railings
- Integrates easily into new or existing railings
- Simple design requires no extra fasteners to install and is virtually hidden from view
- Can be powered in conjunction with AZEK Lighted Post Caps
- Fully adjustable to fit any length railing section

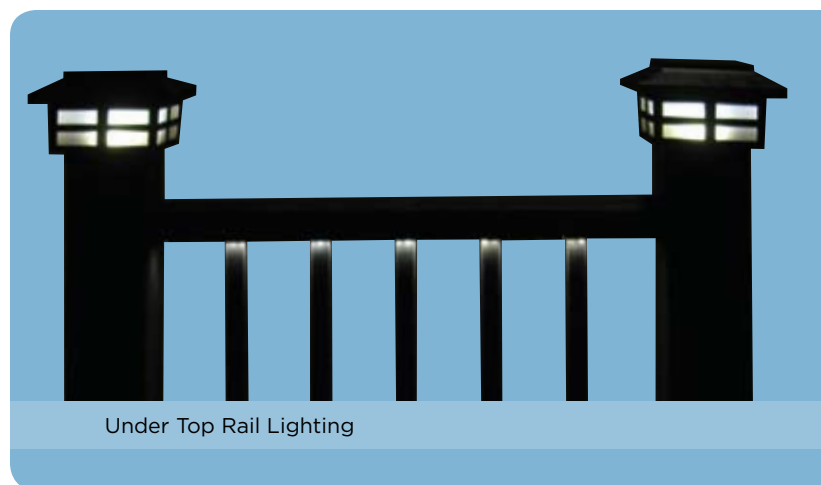

Under Top Rail Lighting

## LIGHTED POST CAPS

- Available in two styles:
  - Island Cap
  - Villa™ Cap
- Fit all AZEK Rail 5 x 5 Posts
- Powered by low voltage power supply
- Create warm deck ambiance
- Complement existing AZEK Post Caps



Villa™ Cap (available in White and Black)



Island Cap (available in White, Black, Brownstone, and Kona®)

Technical Specifications for all  
AZEK Lighting products on reverse.  
For additional info, visit [www.AZEK.com](http://www.AZEK.com)  
or call (877) ASK-AZEK.

## Technical Specifications for AZEK Rail Lighting

### UNDER TOP RAIL LIGHTING

- Kit includes LED strip and LED extrusion
- Kits can light 6' or 8' of rail sections
- Can be cut to custom lengths
- 18 LEDs per foot
- Powered by 12 V DC power supply
- AZEK Power Pack Sold Separately
- Works with AZEK Premier or Trademark Rail



LED Extrusion

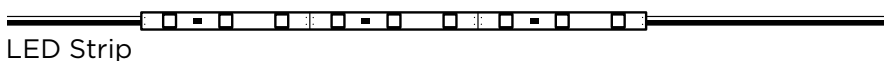

LED Strip

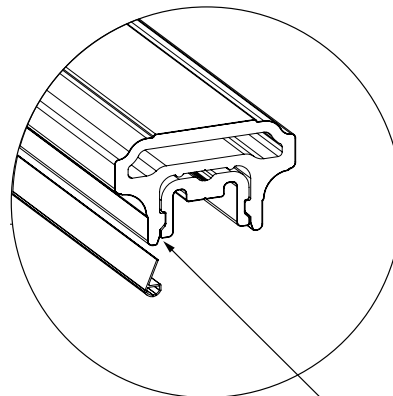

LED Strips are inserted into LED Extrusions and press fit between Top Rail Retainer and Hand Rail

### LIGHTED POST CAPS

#### Villa™ Cap

- Dimensions: 8 7/8" x 8 7/8" x 5 1/2"
- 3 LEDs per cap
- Powered by 12 V DC power supply
- Fits 5x5 AZEK Post Sleeve
- Easily integrates with AZEK Under Top Rail Lighting
- AZEK Power Pack sold separately

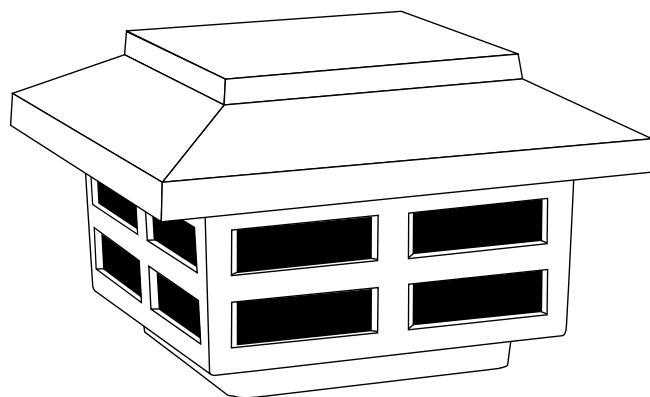

#### Island Cap

- Dimensions: 8" x 8" x 3 1/4" (same dimensions as AZEK 5 x 5 Island Cap)
- 12 LEDs per cap
- Powered by 12 V DC power supply
- Fits 5x5 AZEK Post Sleeve
- Easily integrates with AZEK Under Top Rail Lighting
- AZEK Power Pack sold separately

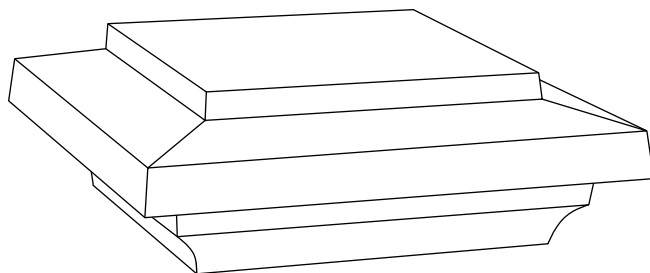

#### AZEK Power Packs (Sold Separately)

- Two size transformers available:
  - 35W - Powers Lighted Post Caps only
  - 200W - Powers Under Top Rail Lighting alone or with Lighted Post Caps
- 100 ft. of 12 gauge wire
- 20 waterproof wire connectors
- Multi-point terminal block
- Bus bars

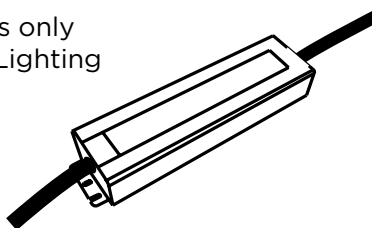

Transformer  
(either 35 watt or 200 watt)

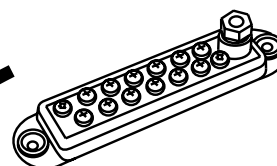

Two Bus Bars

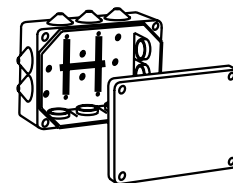

Multi-Point  
Terminal Block



Wire Connectors



Wire